



TDEPD

**Field-Programmable
Pressure Switch/Transducer
with Integrated LED Display**

Programming Sequence Manual

Wiring Diagram

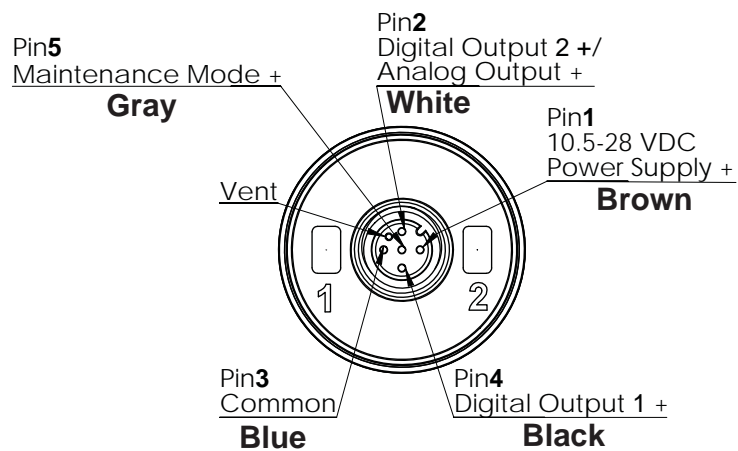

Note: Any wires that are not electrically connected should be capped off with a small wire nut to prevent potential electrical shorts.

TDEPD

Field-Programmable Pressure Switch/Transducer with Integrated LED Display Programming Sequence Manual

Definitions



PB1 = Press the #1 button briefly

PB2 = Press the #2 button briefly

PB1 for x = Press and hold the #1 button for x seconds

PB2 for x = Press and hold the #2 button for x seconds

Press BOTH for x = Press and hold both buttons at the same time for x seconds

NOTE: After 30 seconds of inactivity on the pushbuttons, the TDEPD will automatically return to normal mode displaying pressure.

Digit Placement

In sections of the manual that refer to setting a value or setpoint, "first," "second," "third," "fourth," digits, etc. are referenced as in the following diagram:

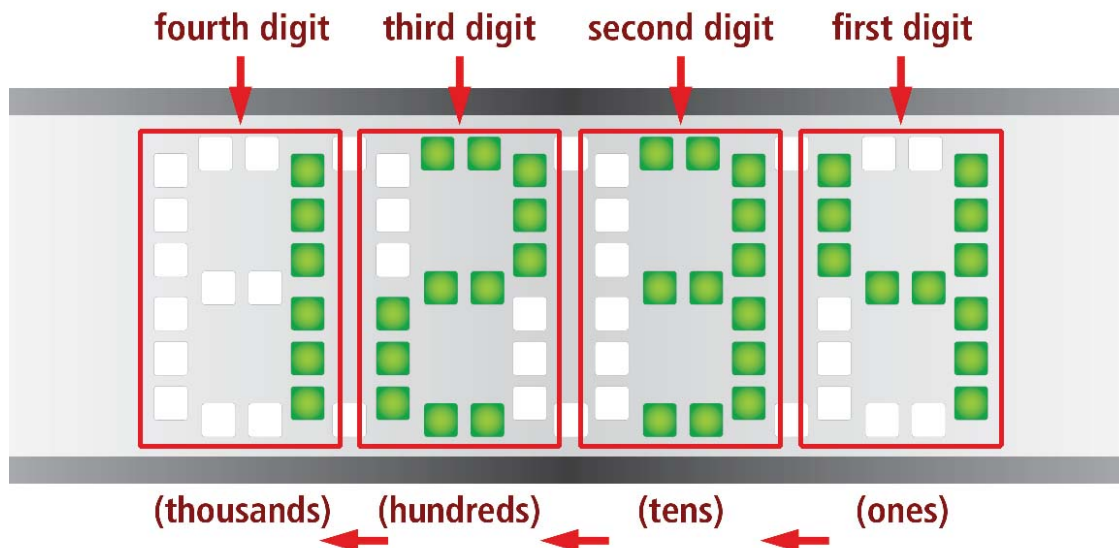

View/Program Sensor Characteristics

Press BOTH for 3 seconds to enter programming mode

Function: Places user in programming mode

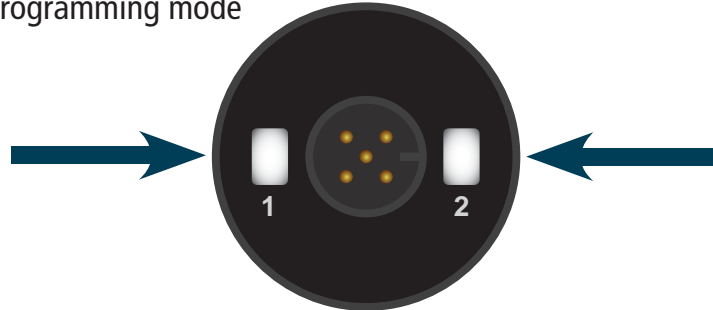

NOTE: Programming parameters follow the sequence below. In order to return to a previous parameter, allow for 30 seconds of inactivity to return to normal mode and begin sequence again by pressing BOTH for 3 seconds to enter programming mode, beginning with step 1.

ORIENTATION OF DISPLAY

1: **Function:** Change orientation of display (right-side up or upside down)
Display "OriE"

- PB2 to alternate between right-side up and upside down

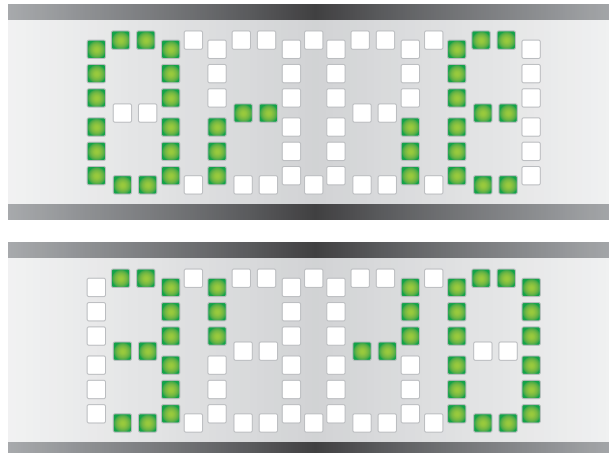

- PB1 to save change and move to next parameter

Changes will ONLY be saved by PB1 and moving to the next parameter. If the TDEPD times out before PB1, changes will NOT be saved.

POSITION OF DISPLAY

2: **Function:** Change position of display
Display "POS1"

- PB2 to move position one digit



- PB1 to save change and move to the next parameter

NOTE: PB2 moves the position 1 place to the right around the unit. It does not move to the left. To move further left, use PB2 to circle the unit to the right to the desired place.

TYPE OF OUTPUT

3: **Function:** Change the type of output for Digital Output 1
Display the current output type: "1nPn" or "1PnP" **[250 mA max for (PNP) or 200 mA max for (NPN)]**

- PB2 to change type

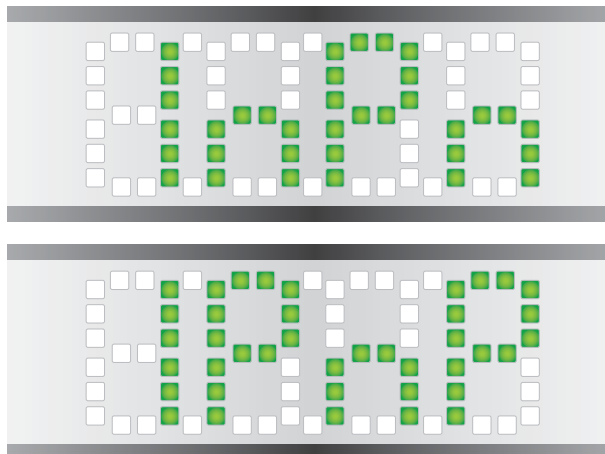

- PB1 to save change and move to the next parameter

FUNCTION OF OUTPUT

4: **Function:** Change the function of Digital Output #1
Display the current output function: "1 no" or "1 nc"
(normally open or normally closed)

- PB2 to change type

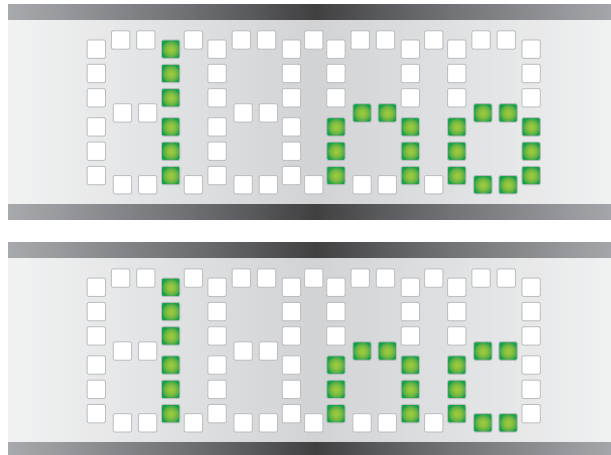

- PB1 to save change and move to the next parameter

LOW SETPOINT COLOR

5: **Function:** Change the display color when the pressure is below the lower setpoint
Display "1 lo" in the desired color (red or green)

- PB2 to change color

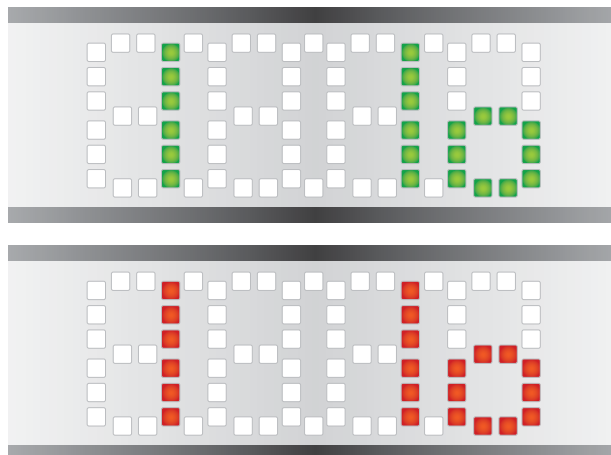

- PB1 to save change and move to the next parameter

SET LOW SETPOINT

6: Function: Change the lower setpoint
(default setting is 10% of full pressure range)
Display: Flash between "1 LS" and the actual setpoint

- PB2 to enter change setpoint mode
 - PB2 to change the first digit +1 (9 + 1 cycles back to 0)
 - PB2 for 3 seconds and release to move to the next digit.
(On release, active digit will blink on and off)
- Next digit after thousands cycles back to ones.

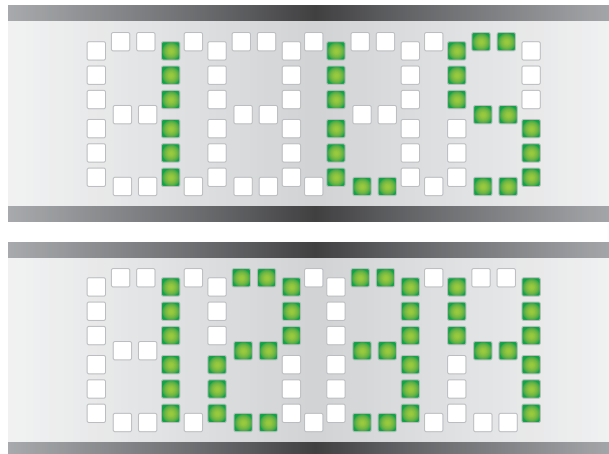

NOTE: Setpoint defaults to minimum 5 psi for units 100 psi or less and 10% of configured pressure range above 100 psi. For example, a unit configured for 250 psi will have a minimum set point of 25 psi.

- PB1 to save change and move to the next parameter

HIGH SETPOINT COLOR

7: **Function:** Change the display color when the pressure is above the higher setpoint
Display "1 hi" in the desired color (red or green)

- PB2 to change color

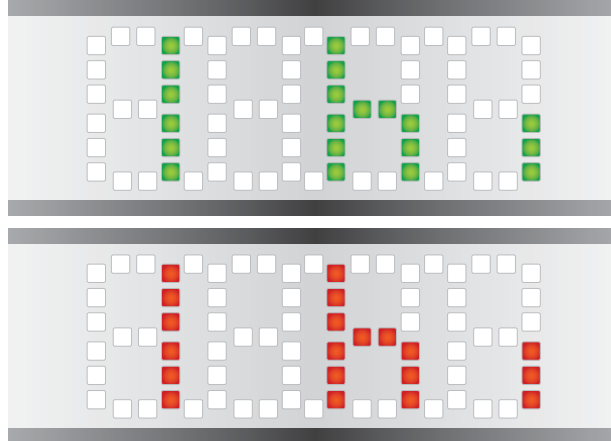

- PB1 to save change and move to the next parameter

SET HIGH SETPOINT

8: **Function:** Change the upper setpoint
(default setting is 90% of full pressure range)
Display: Flash between "1 US" and the actual setpoint

- PB2 to enter change setpoint mode
 - PB2 to change the first digit
 - PB2 for 3 seconds and release to move to the next digit.
(On release, active digit will blink on and off)
- Next digit after thousands cycles back to ones.

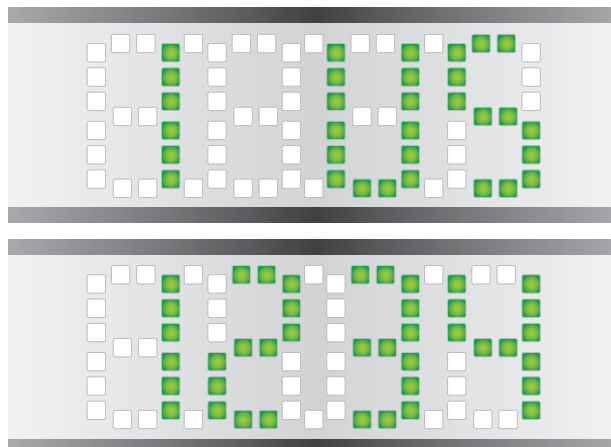

NOTE: Setpoint defaults to minimum 5 psi for units 100 psi or less and 10% of configured pressure range above 100 psi. For example, a unit configured for 250 psi will have a minimum set point of 25 psi.

- PB1 to save change and move to the next parameter

OPTION:

If Digital Output 2 is present (TDEPD2), repeat Steps #3, 4, 6 & 8 for this output. [250 mA max for (PNP) or 200 mA max for (NPN)]

NOTE: All instructions will be identical in Steps #3, 4, 6, & 8, but the initial number on the display will be 2 instead of 1. For example:

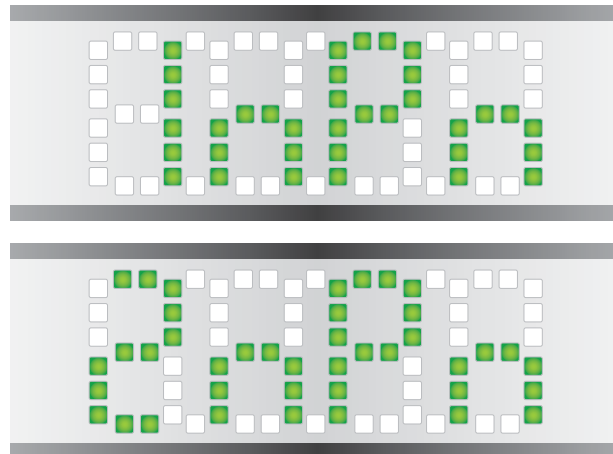

OPTION:

If the Analog Output is present (TDEPD3), continue to perform Steps #9 through #11. If no Analog Output is available, sequence will forward to Step #12.

PROGRAM ANALOG OUTPUT

9: **Function:** Program the type of analog output (voltage or current)
Display: "volt" for voltage or "Curr" for current

- PB2 to change the type of analog output

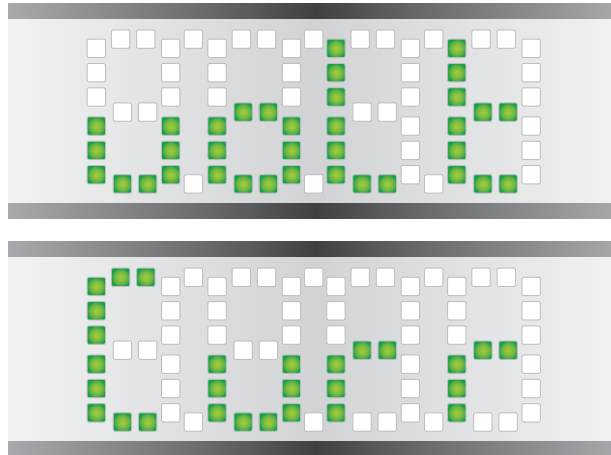

- PB1 to save change and move to the next parameter

10: **Function:** Program the analog output value at the minimum pressure
Display: Flash between "A Lo" and the actual value

- PB2 to enter change value mode
 - PB2 and release to change the digit.
(On release, active digit will blink on and off)
 - PB2 for 3 seconds to move to the next digit

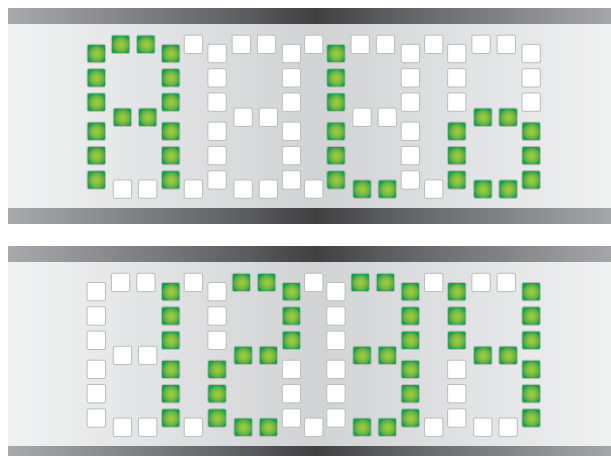

- PB1 to save change and move to the next parameter

11: **Function:** Program the analog output value at the maximum pressure
 Display: Flash between "A Hi" and the actual value

- PB2 to enter change value mode
 - PB2 and release to change the first digit.
 (On release, active digit will blink on and off)
 - PB2 for 3 seconds to move to the next digit

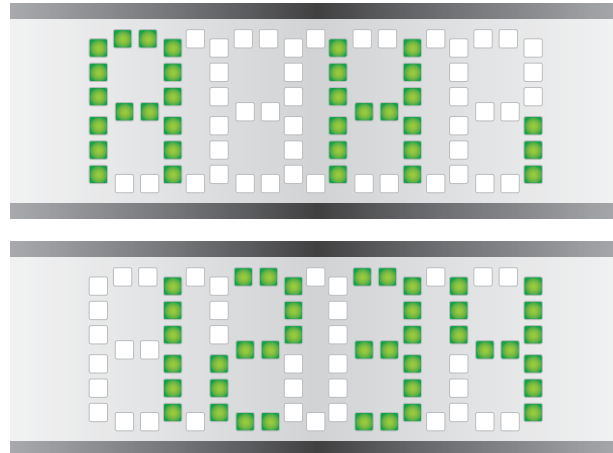

- PB1 to save change and move to the next parameter

SET DISPLAY SPIN FUNCTION

12: Function: Program whether the display rotates continuously
 Display: "noSP"
 (if the display doesn't rotate or "SPin" if the display rotates continuously)

- PB2 to change whether the display rotates or not

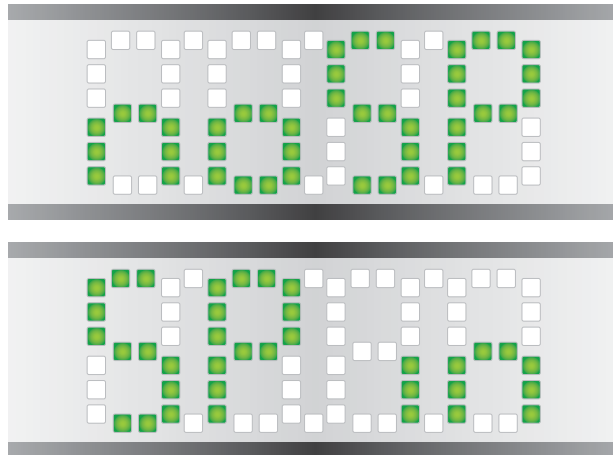

- PB1 to save change and return to normal mode

NOTE: If set to SPIN, upon re-entering programming sequence, active digits on display will revert to Step #2 setting for POSI(tion) for ease of programming.

NOTE: After 30 seconds of inactivity on the pushbuttons, the TDEPD will automatically return to normal mode displaying pressure.

NOTE: Missing any steps or requiring a change to any steps in the sequence can be remedied by allowing for inactivity, returning to normal mode, and re-entering the programming sequence beginning at Step #1 to make the necessary changes.

Additional Functions

PB1 for 10 sec.

Function: Spike Counter.

You will see how many pressure spikes that spike counter #1 saw that were 1.2x and above the rated pressure. This number will rotate around the display one time (GREEN).

Then you will see how many pressure spikes that spike counter #2 saw that were 2x and above the rated pressure. This number will rotate around the display one time (GREEN).

Finally you will see the maximum pressure spike seen in psi. This will rotate around the display one time (RED).

These numbers cannot be reset in the field. Return to Transducers Direct for reset.

PB2 for 10 sec.

Function: Zero/Tare Display

Press button #2 for 10 sec. If the pressure reading on the display is between -14.7 and 128 psi, the display will change to zero (0). If pressure is above 128 psi, display will not change.

Minimum/Lowest Setpoint

5 psi for units 100 psi or less
10% of configured pressure range above 100 psi

Setpoint Information

By setting the HIGH and LOW set points, you are saving the points at which the digital output(s) is activated and deactivated thusly creating the hysteresis between the two. Setting "normally open" and "normally closed" is based on the state of the digital output at zero pressure.

Pressure (psi) In this example, "normally open" (no) has been selected. The digital output is active or "on" when the pressure reaches 60psi and deactivated or "off" at 30psi.

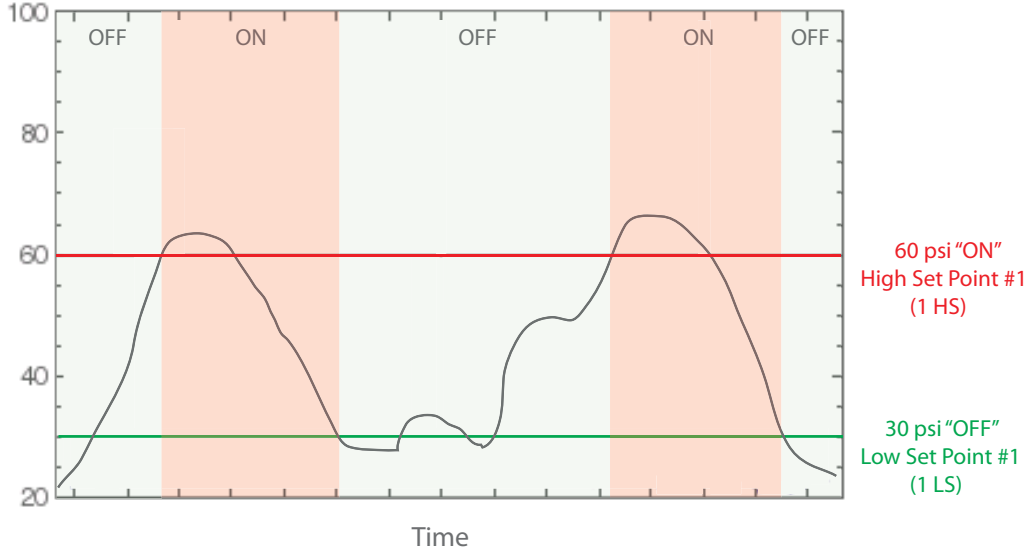

Maintenance Mode

Maintenance Mode on the TDEPD is a digital output (pin 5 / gray wire) that activates if there is a half bridge failure on the unit typically due to pressure spikes or high shock or vibration. The TDEPD will still function but the digital output signal is to notify the user that the unit should be replaced before the other half bridge fails. The user should address any spike or high shock & vibration issues in the system at that time.

Example Wiring Diagram for Digital Outputs

(1).NPN OUTPUT TYPE

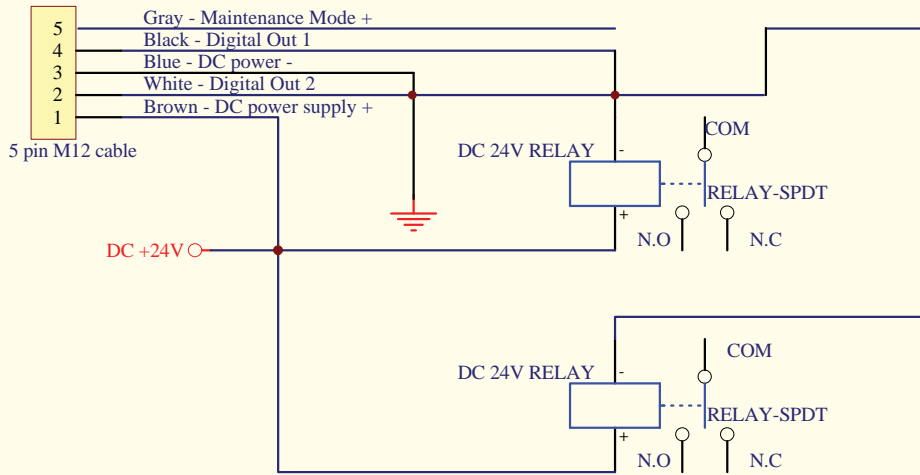

(2).PNP OUTPUT TYPE

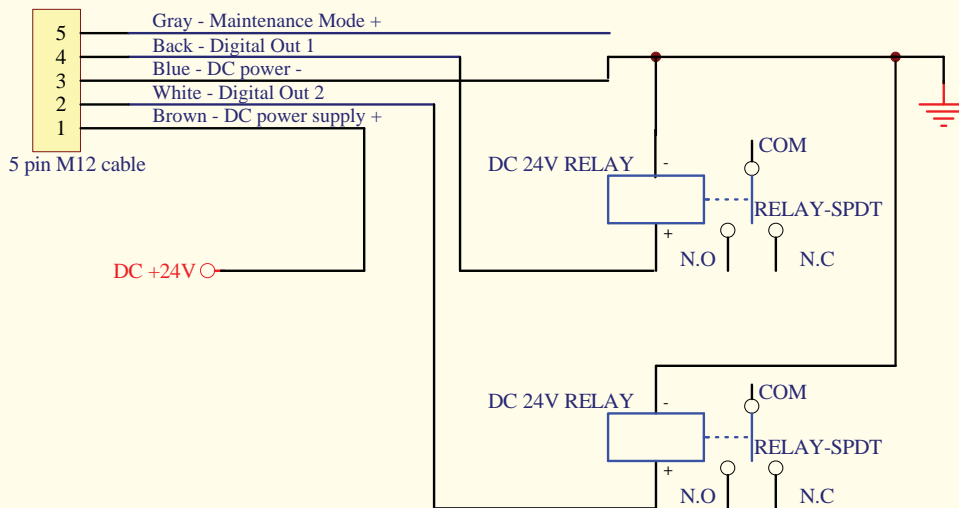



Transducers Direct, LLC
12115 Ellington Court
Cincinnati, OH 45249

P • 513-583-9491

F • 513-583-9476

sales@transducersdirect.com

www.TransducersDirect.com